

Power MOSFET

PRODUCT SUMMARY		
V_{DS} at T_J max. (V)	650	
$R_{DS(on)}$ (Ω)	$V_{GS} = 10$ V	0.190
Q_g (Max.) (nC)	98	
Q_{gs} (nC)	17	
Q_{gd} (nC)	25	
Configuration	Single	

FEATURES

- High E_{AR} Capability
- Lower Figure-of-Merit $R_{on} \times Q_g$
- 100 % Avalanche Tested
- High Peak Current Capability
- dV/dt Ruggedness
- Effective C_{OSS} Specified
- Improved Transconductance
- Improved t_{rr}/Q_{rr}
- Improved Gate Charge
- High Power Dissipation Capability
- Compliant to RoHS Directive 2002/95/EC

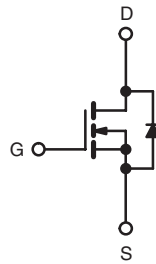
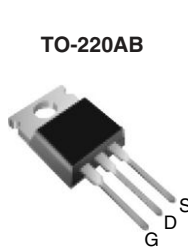

N-Channel MOSFET

ORDERING INFORMATION	
Package	TO-220AB
Lead (Pb)-free	SiHP22N60S-E3

ABSOLUTE MAXIMUM RATINGS ($T_C = 25$ °C, unless otherwise noted)					
PARAMETER	SYMBOL		LIMIT	UNIT	
Drain-Source Voltage	V_{DS}		600	V	
Gate-Source Voltage	V_{GS}		± 20		
Continuous Drain Current ^a	V_{GS} at 10 V	$T_C = 25$ °C	22	A	
		$T_C = 100$ °C	13		
Pulsed Drain Current ^b	I_{DM}		65		
Linear Derating Factor	TO-220AB		2	W/°C	
Single Pulse Avalanche Energy ^c	E_{AS}		690	mJ	
Repetitive Avalanche Energy ^b	E_{AR}		25		
Maximum Power Dissipation	TO-220AB		P_D	250	W
Peak Diode Recovery dV/dt ^d	dV/dt		7.3	V/ns	
Operating Junction and Storage Temperature Range	T_J, T_{stg}		- 55 to + 150	°C	
Soldering Recommendations (Peak Temperature) ^e	for 10 s		300		

Notes

- Limited by maximum junction temperature.
- Repetitive rating; pulse width limited by maximum junction temperature.
- $V_{DD} = 50$ V, starting $T_J = 25$ °C, $L = 28.2$ mH, $R_g = 25$ Ω , $I_{AS} = 7$ A.
- $I_{SD} \leq 22$ A, $dI/dt \leq 340$ A/ μ s, $V_{DD} \leq V_{DS}$, $T_J \leq 150$ °C.
- 1.6 mm from case.

* Pb containing terminations are not RoHS compliant, exemptions may apply

THERMAL RESISTANCE RATINGS

PARAMETER		SYMBOL	TYP.	MAX.	UNIT
Maximum Junction-to-Ambient	TO-220AB	R_{thJA}	-	62	°C/W
Maximum Junction-to-Case (Drain)	TO-220AB	R_{thJC}	-	0.5	

SPECIFICATIONS ($T_J = 25\text{ °C}$, unless otherwise noted)

PARAMETER	SYMBOL	TEST CONDITIONS		MIN.	TYP.	MAX.	UNIT
Static							
Drain-Source Breakdown Voltage	V_{DS}	$V_{GS} = 0\text{ V}, I_D = 1\text{ mA}$		600	-	-	V
V_{DS} Temperature Coefficient	$\Delta V_{DS}/T_J$	Reference to 25 °C , $I_D = 1\text{ mA}$		-	0.70	-	V/°C
Gate-Source Threshold Voltage (N)	$V_{GS(th)}$	$V_{DS} = V_{GS}, I_D = 250\text{ }\mu\text{A}$		2.0	-	4.0	V
Gate-Source Leakage	I_{GSS}	$V_{GS} = \pm 20\text{ V}$		-	-	± 100	nA
Zero Gate Voltage Drain Current	I_{DSS}	$V_{DS} = 600\text{ V}, V_{GS} = 0\text{ V}$		-	-	1	μA
		$V_{DS} = 600\text{ V}, V_{GS} = 0\text{ V}, T_J = 150\text{ °C}$		-	-	100	
Drain-Source On-State Resistance	$R_{DS(on)}$	$V_{GS} = 10\text{ V}$	$I_D = 22\text{ A}$	-	0.160	0.190	Ω
Forward Transconductance ^a	g_{fs}	$V_{DS} = 50\text{ V}, I_D = 13\text{ A}$		-	9.4	-	S
Dynamic							
Input Capacitance	C_{iss}	$V_{GS} = 0\text{ V},$ $V_{DS} = 25\text{ V},$ $f = 1.0\text{ MHz}$		-	2810	-	pF
Output Capacitance	C_{oss}			-	1480	-	
Reverse Transfer Capacitance	C_{rss}			-	33	-	
Effective Output Capacitance (Time Related)	$C_{oss\text{ eff. (TR)}}^a$	$V_{GS} = 0\text{ V}$	$V_{DS} = 0\text{ V to } 480\text{ V}$	-	155	-	
Total Gate Charge	Q_g	$V_{GS} = 10\text{ V}$	$I_D = 22\text{ A}, V_{DS} = 480\text{ V}$	-	75	-	nC
Gate-Source Charge	Q_{gs}			-	17	-	
Gate-Drain Charge	Q_{gd}			-	25	-	
Turn-On Delay Time	$t_{d(on)}$	$V_{DD} = 380\text{ V}, I_D = 22\text{ A},$ $R_g = 9.1\text{ }\Omega, V_{GS} = 10\text{ V}$		-	24	-	ns
Rise Time	t_r			-	68	-	
Turn-Off Delay Time	$t_{d(off)}$			-	77	-	
Fall Time	t_f			-	59	-	
Gate Input Resistance	R_g	$f = 1\text{ MHz}, \text{ open drain}$		-	0.65	-	Ω
Drain-Source Body Diode Characteristics							
Continuous Source-Drain Diode Current	I_S	MOSFET symbol showing the integral reverse p - n junction diode		-	-	22	A
Pulsed Diode Forward Current	I_{SM}			-	-	88	
Diode Forward Voltage	V_{SD}	$T_J = 25\text{ °C}, I_S = 22\text{ A}, V_{GS} = 0\text{ V}$		-	-	1.2	V
Reverse Recovery Time	t_{rr}	$T_J = 25\text{ °C}, I_F = I_S,$ $dI/dt = 100\text{ A}/\mu\text{s}, V_R = 25\text{ V}$		-	462	-	ns
Reverse Recovery Charge	Q_{rr}			-	8.3	-	μC
Reverse Recovery Current	I_{RRM}			-	30	-	A

Note

a. $C_{oss\text{ eff. (TR)}}$ is a fixed capacitance that gives the same charging time as C_{oss} while V_{DS} is rising from 0 % to 80 % V_{DS} .

TYPICAL CHARACTERISTICS (25 °C, unless otherwise noted)

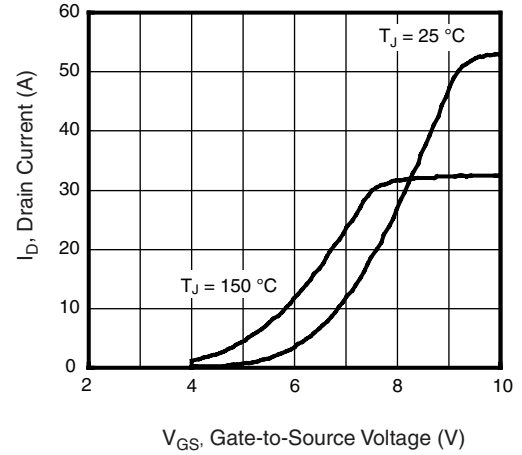
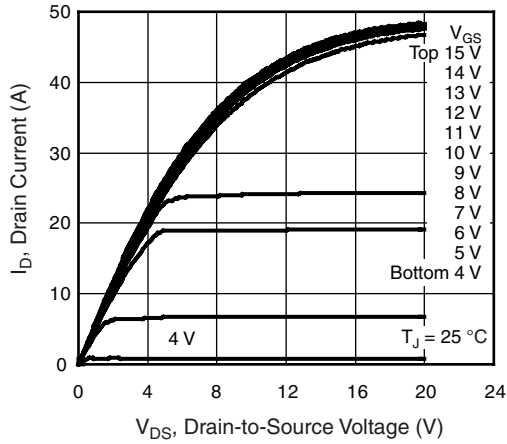

Fig. 1 - Typical Output Characteristics, $T_J = 25\text{ }^\circ\text{C}$

Fig. 3 - Typical Transfer Characteristics

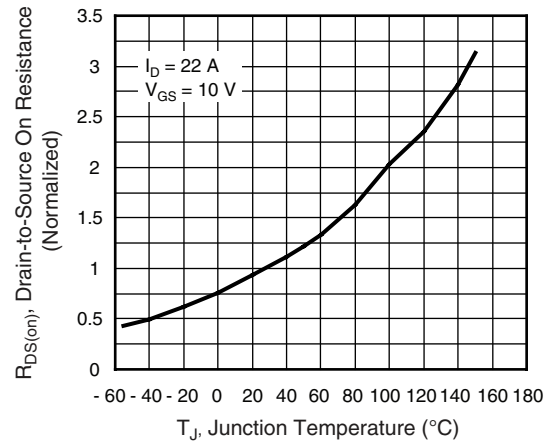
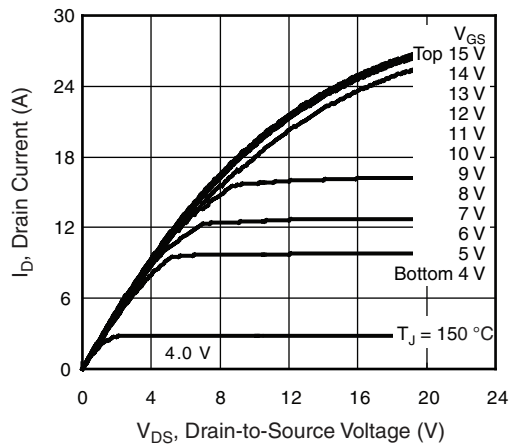

Fig. 2 - Typical Output Characteristics, $T_J = 150\text{ }^\circ\text{C}$

Fig. 4 - Normalized On-Resistance vs. Temperature

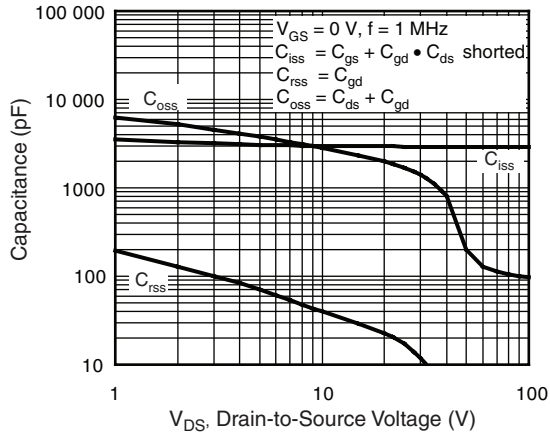

Fig. 5 - Typical Capacitance vs. Drain-to-Source Voltage

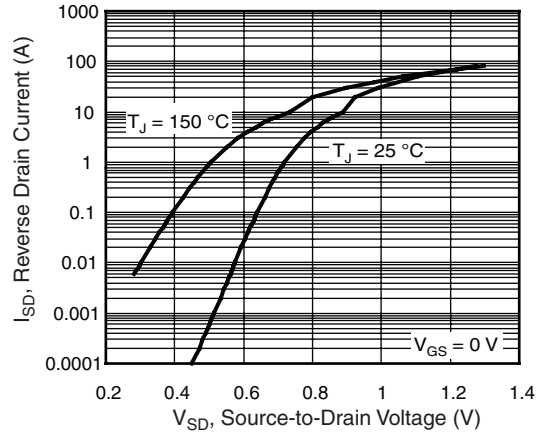

Fig. 7 - Typical Source-Drain Diode Forward Voltage

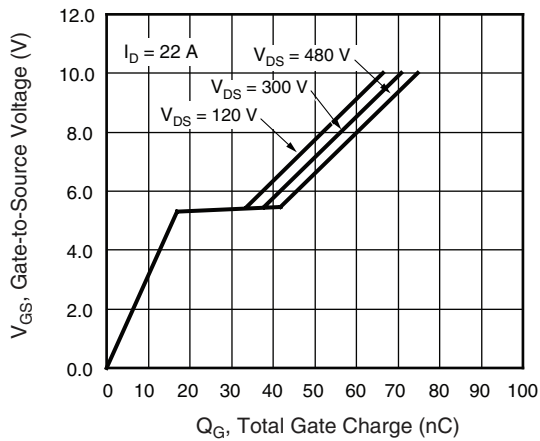

Fig. 6 - Typical Gate Charge vs. Gate-to-Source Voltage

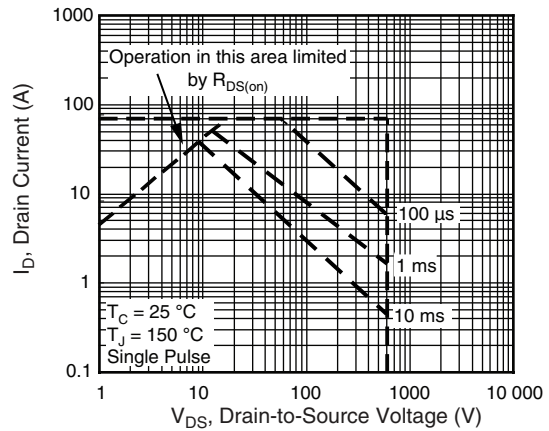

Fig. 8 - Maximum Safe Operating Area

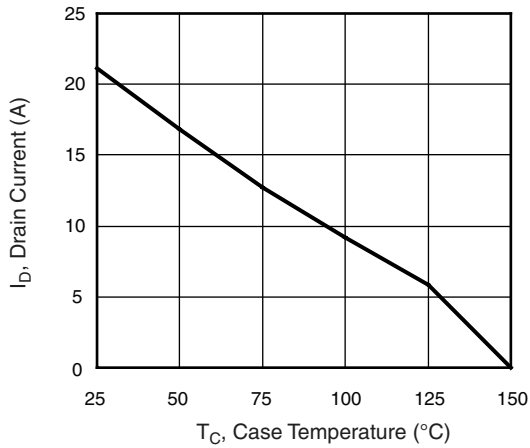

Fig. 9 - Maximum Drain Current vs. Case Temperature

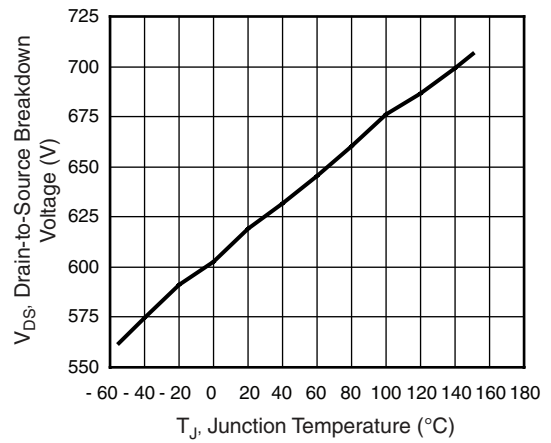

Fig. 10 - Drain-to-Source Breakdown Voltage

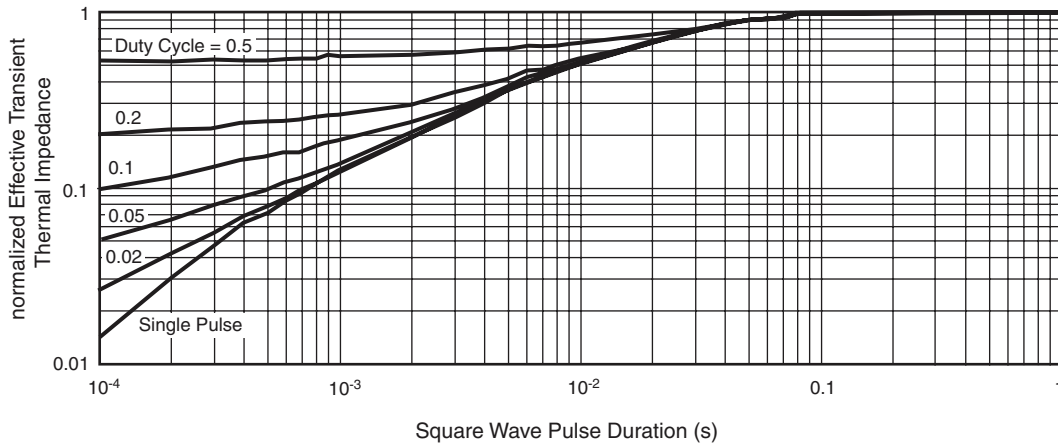

Fig. 11 - Normalized Thermal Transient Impedance, Junction-to-Case

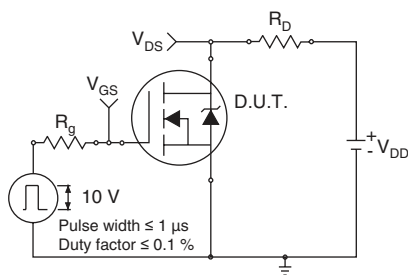

Fig. 11a - Switching Time Test Circuit

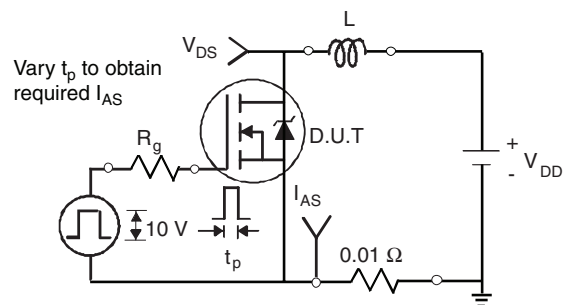

Fig. 12a - Unclamped Inductive Test Circuit

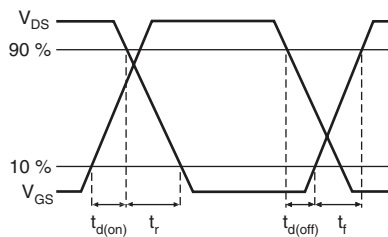

Fig. 11b - Switching Time Waveforms

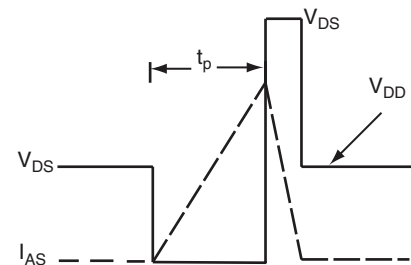

Fig. 12b - Unclamped Inductive Waveforms

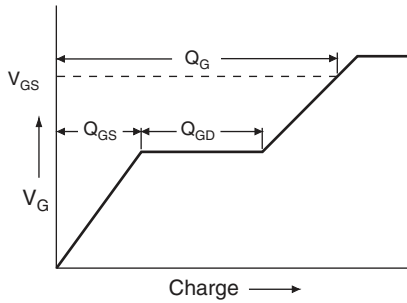

Fig. 13a - Basic Gate Charge Waveform

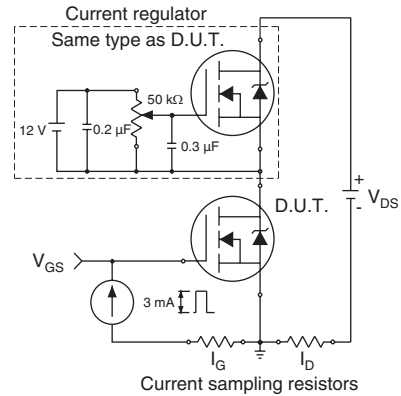
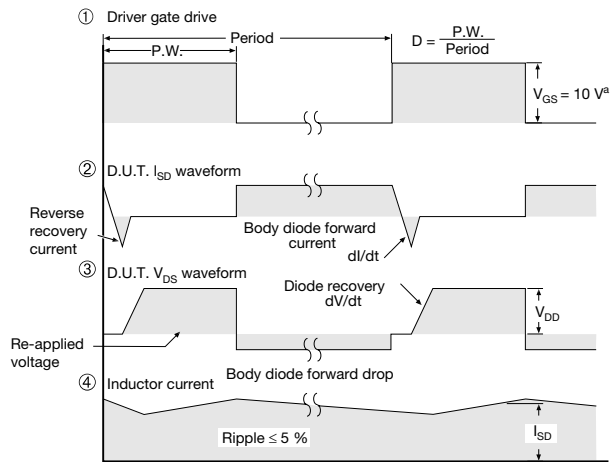
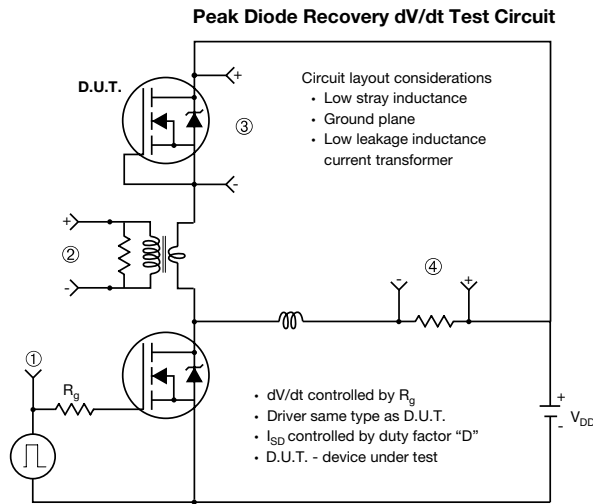

Fig. 13b - Gate Charge Test Circuit



Note
a. $V_{GS} = 5\text{ V}$ for logic level devices

Fig. 14 - For N-Channel

Vishay Siliconix maintains worldwide manufacturing capability. Products may be manufactured at one of several qualified locations. Reliability data for Silicon Technology and Package Reliability represent a composite of all qualified locations. For related documents such as package/tape drawings, part marking, and reliability data, see www.vishay.com/ppg?91373.



Disclaimer

All product specifications and data are subject to change without notice.

Vishay Intertechnology, Inc., its affiliates, agents, and employees, and all persons acting on its or their behalf (collectively, "Vishay"), disclaim any and all liability for any errors, inaccuracies or incompleteness contained herein or in any other disclosure relating to any product.

Vishay disclaims any and all liability arising out of the use or application of any product described herein or of any information provided herein to the maximum extent permitted by law. The product specifications do not expand or otherwise modify Vishay's terms and conditions of purchase, including but not limited to the warranty expressed therein, which apply to these products.

No license, express or implied, by estoppel or otherwise, to any intellectual property rights is granted by this document or by any conduct of Vishay.

The products shown herein are not designed for use in medical, life-saving, or life-sustaining applications unless otherwise expressly indicated. Customers using or selling Vishay products not expressly indicated for use in such applications do so entirely at their own risk and agree to fully indemnify Vishay for any damages arising or resulting from such use or sale. Please contact authorized Vishay personnel to obtain written terms and conditions regarding products designed for such applications.

Product names and markings noted herein may be trademarks of their respective owners.